

Ultraliner Range

SAC007U

Technical Data Sheet

ultraliner®

milkrite Product Code	milkrite Part Number	Alternative To
SAC007U	200093-01	25215007

Material Approval



The compound used for this liner meets BfR Food Regulation XXI Category 3 for products that come into contact with food, and is approved to this standard by RAL. Our materials are REACH compliant.

Shell Type: N/A

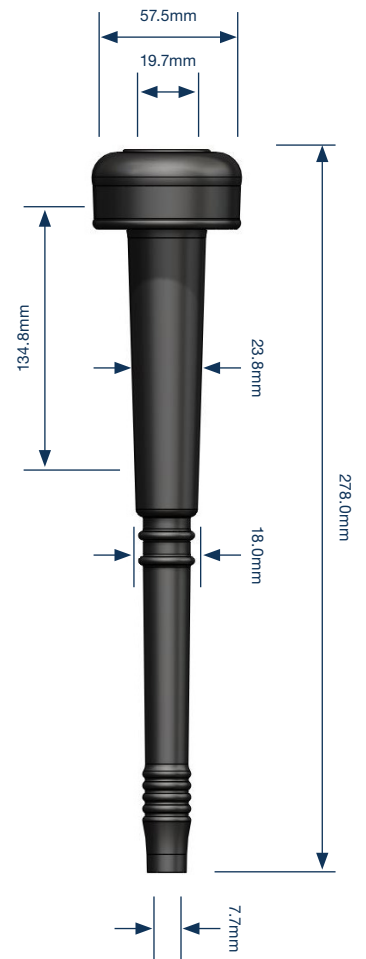
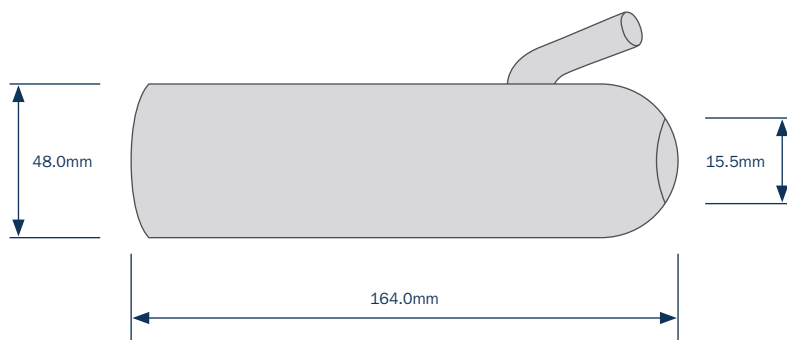

Warranty

milkrite liners are warranted to last a minimum of 2500 milkings or six months when used in accordance with our instructions and those of the parlour manufacturer.

The information in this document is not binding and can be changed without notice. Parlours and herds vary considerably, so these details are meant to be guidelines to operation only and not a specification. It remains the responsibility of the operator to ensure the correct working of the plant and the health of the animal.

milkrite, Hampton Park West, Semington Road, Melksham, Wiltshire SN12 6NB, UK



www.milkrite-interpuls.com

milkrite | InterPuls
Improving every farm we touch